

6

5

4

3

2

1

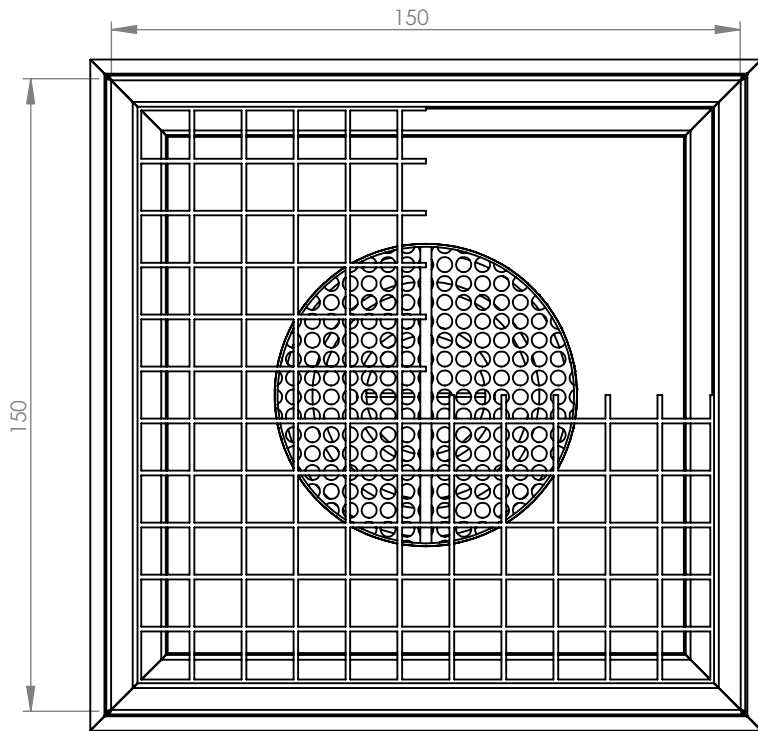

Grid

Siphon

Basket

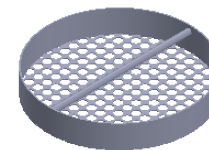
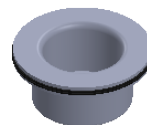
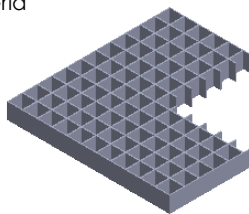
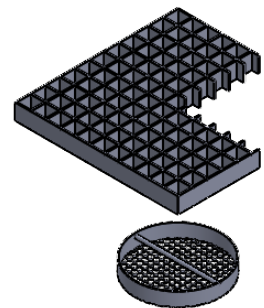
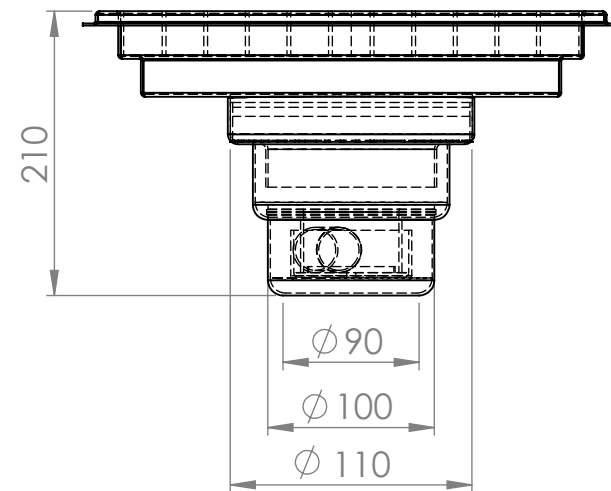

**EN
1253**

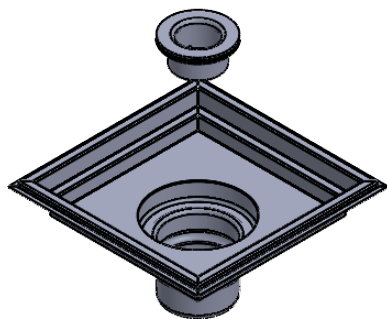

UNLESS OTHERWISE INDICATED:
DIMENSIONS ARE EXPRESSED IN MM
SURFACE FINISH:
TOLERANCES:
LINEAR:
ANGULAR:

FINISHING

Blasting

DO NOT CHANGE THE SCALE

REVISED

	NAME	SIGNING	DATE		
DRAW.	D.Manzanares R.		02-03-22		
VERIF.	D.Manzanares		16-02-22		
APROB.					
FABR.					
QUAL.					
				MATERIAL:	
				A-304	
				WEIGHT	



TITLE

DAR.SUM.K.1515.GE.090V

N.º OF DRAWING

DM-0016-22

A4

SCALE:1:5

SHEET 1 OF 1

6

5

4

3

2

1

D

D

C

C

B

B

A

A